

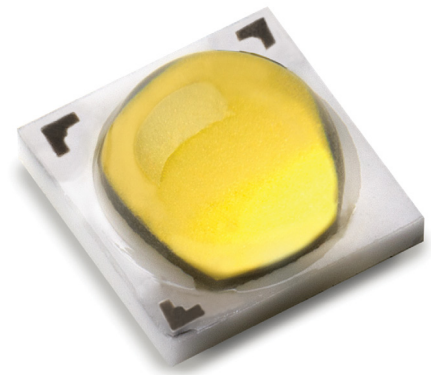

LUXEON T

明亮、多用途及高效发光器

LUXEON T 设计可提供高效率及高光通密度，为定向及高流明应用提供精准的光束控制。LUXEON T 已经按真实世界的工作条件— 85°C 进行测试和验证，挣脱分档藩篱，并具有领先的性能，可确保应用内性能。LUXEON T LED 可实现高效率与低成本的最佳组合，助力系统优化，该 LED 还具有紧密相连的色温，可确保系统颜色点的一致性。



性能与利益

三阶和五阶麦克亚当椭圆分群: 摆脱分档藩篱，确保超卓的光线质量

低 V_f 和热阻，可采用尺寸更小的散热器，提供更高的流明

高照度和小光源，确保在定向应用中实现精准光束控制

紧凑的光源提供卓越的效率和光输出

应用

筒灯

高棚和低棚

室内区域照明

灯泡

室外

Table of Contents

General Product Information	2
Product Test Conditions	2
Part Number Nomenclature	2
Lumen Maintenance	2
Environmental Compliance	2
Performance Characteristics	3
Product Selection Guide	3
Optical Characteristics	3
Electrical and Thermal Characteristics	4
Absolute Maximum Ratings	4
Characteristic Curves	5
Spectral Power Distribution Characteristics	5
Light Output Characteristics	7
Forward Current Characteristics	8
Radiation Pattern Characteristics	9
Product Bin and Labeling Definitions	10
Decoding Product Bin Labeling	10
Luminous Flux Bins	11
Radiometric Power Bins	11
Color Bin Definition	12
Peak Wavelength Bins	13
Forward Voltage Bins	13
Mechanical Dimensions	14
Reflow Soldering Guidelines	15
Solder Pad Design	16
Packaging Information	17
Pocket Tape Dimensions	17
Reel Dimensions	18

General Product Information

Product Test Conditions

LUXEON T LEDs are tested and binned with a DC drive current of 700mA at a junction temperature, T_j , of 85°C.

Part Number Nomenclature

Part numbers for LUXEON T follow the convention below:

L X H **A** – F W **B B** – **C** and
L X H **A** – F W **B B** – **D D D D**

Where:

- A** – designates minimum CRI performance (7=70CRI, 8=80CRI, 9=90CRI and I for Royal Blue)
- B B** – designates nominal ANSI CCT (27=2700K, 30=3000K and RB for Royal Blue)
- C** – designates color defintion (3=3 SDCM and 5=5 SDCM)
- D D D D** – designates minimum luminious flux output (1000=1000mW)

Therefore, the following part number is used for a LUXEON T White 3-step MacAdam ellipse, 3000K 80CRI:

L X H **8** – F W **3 0** – **3** and

Therefore, the following part number is used for a LUXEON T Royal Blue with a minimum radiometric power of 1000mA:

L X H **1** – F W **R B** – **1 0 0 0**

Lumen Maintenance

Please contact your local Sales Representative or Lumileds Technical Solutions Manager for more information about the long-term performance of this product.

Environmental Compliance

Lumileds LLC is committed to providing environmentally friendly products to the solid-state lighting market. LUXEON T is compliant to the European Union directives on the restriction of hazardous substances in electronic equipment, namely the RoHS Directive 2011/65/EU and REACH Regulation (EC) 1907/2006. Lumileds LLC will not intentionally add the following restricted materials to its products: lead, mercury, cadmium, hexavalent chromium, polybrominated biphenyls (PBB) or polybrominated diphenyl ethers (PBDE).

Performance Characteristics

Product Selection Guide

Table 1a. Product performance of LUXEON T white at 700mA and 350mA, $T_j=85^\circ\text{C}$.

NOMINAL CCT	MINIMUM CRI ^[1]	LUMINOUS FLUX ^[2] (lm)		TYPICAL LUMINOUS EFFICACY (lm/W)	TYPICAL LUMINOUS FLUX (lm)	TYPICAL LUMINOUS EFFICACY (lm/W)	PART NUMBER
		MINIMUM	TYPICAL				
		700mA					
3000K	70	200	218	111	117	123	LXH7-FW30
4000K	70	210	249	127	133	140	LXH7-FW40
5000K	70	220	255	130	136	143	LXH7-FW50
5700K	70	220	255	130	136	143	LXH7-FW57
6500K	70	220	255	130	136	143	LXH7-FW65
2700K	80	170	186	95	100	105	LXH8-FW27-x
3000K	80	180	197	101	106	112	LXH8-FW30-x
3500K	80	190	208	106	112	118	LXH8-FW35-x
4000K	80	190	212	108	114	120	LXH8-FW40-x
5000K	80	190	222	113	120	127	LXH8-FW50-x
3000K	95 typ	130	160	82	86	91	LXH9-FW30-x

Notes for Table 1a:

1. Lumileds maintains a tolerance of ± 2 on CRI.
2. Lumileds maintains a tester tolerance of $\pm 6.5\%$ on luminous flux measurements.

Table 1b. Product performance for LUXEON T Royal Blue at 700mA, $T_j=85^\circ\text{C}$.

PEAK WAVELENGTH (nm)		RADIOMETRIC POWER (mW)		PART NUMBER
MINIMUM	MAXIMUM	MINIMUM	TYPICAL	
445	460	950	1040	LXH1-FWRB

Notes for Table 1b:

1. Lumileds maintains a tolerance of $\pm 2\text{nm}$ on peak wavelength measurements.

Optical Characteristics

Table 2. Optical characteristics for LUXEON T at 700mA.

PART NUMBER	TYPICAL TOTAL INCLUDED ANGLE ^[1]	TYPICAL VIEWING ANGLE ^[2]
LXH7-FWxx	160°	120°
LXHx-FWxx-x	160°	120°
LXH1-FWRB	160°	120°

Notes for Table 2:

1. Total angle at which 90% of total luminous flux is captured.
2. Viewing angle is the off axis angle from the LED centerline where the luminous intensity is $\frac{1}{2}$ of the peak value.

Electrical and Thermal Characteristics

Table 3. Electrical and thermal characteristics for LUXEON T at 700mA, $T_j=85^\circ\text{C}$.

PART NUMBER	FORWARD VOLTAGE (V) ^[1]			TYPICAL TEMPERATURE COEFFICIENT OF FORWARD VOLTAGE (mV/°C) ^[2]	TYPICAL THERMAL RESISTANCE — JUNCTION TO SOLDER PAD (°C/W)
	MINIMUM	TYPICAL	MAXIMUM		
LXH7-FWxx	2.50	2.80	3.25	-1.60	3.00
LXH8-FWxx-x	2.50	2.80	3.25	-1.60	3.00
LXH1-FWRB	2.50	2.80	3.25	-1.60	3.00

Notes for Table 3:

1. Lumileds maintains a tolerance of $\pm 0.06\text{V}$ on forward voltage measurements.

Absolute Maximum Ratings

Table 4. Absolute maximum ratings for LUXEON T, $T_j=85^\circ\text{C}$.

PARAMETER	MAXIMUM PERFORMANCE
DC Forward Current ^[1,2]	1050mA
Peak Pulsed Forward Current ^[1,3]	1200mA
LED Junction Temperature ^[1] (DC & Pulse)	150°C
ESD Sensitivity (ANSI/ESDA/JEDEC JS-001-2012)	Class B
Operating Case Temperature ^[1]	-40°C to 135°C
LED Storage Temperature	-40°C to 135°C
Soldering Temperature	JEDEC 020c 260°C
Allowable Reflow Cycles	3
Reverse Voltage ^[4,5] (V_{reverse})	LUXEON LEDs are not designed to be driven in reverse bias

Notes for 4:

1. Proper current derating must be observed to maintain junction temperature below the maximum. For additional information on thermal measurement guidelines please refer to Application Brief AB106.
2. Residual periodic variations due to power conversion from alternating current (AC) to direct current (DC), also called "ripple", with frequencies $\geq 100\text{ Hz}$ and amplitude $\leq 150\text{mA}$ are acceptable, assuming the average current throughout each cycle does not exceed the maximum allowable DC Forward Current at the corresponding maximum junction temperature.
3. Pulsed operation with a peak drive current equal to the stated Peak Pulsed Forward Current is acceptable if the pulse on-time is $\leq 5\text{ms}$ per cycle and the duty cycle is $\leq 50\%$.
4. Transient reverse voltages and surge currents due to electrical switching or supply interruptions are acceptable if these events do not last for more than 10ms, the amplitude of the reverse voltage does not exceed 5V and the reverse current is less than 220 μA .
5. Max 5V reverse for up to 10s is an acceptable beginning of life, one time test condition.

Characteristic Curves

Spectral Power Distribution Characteristics

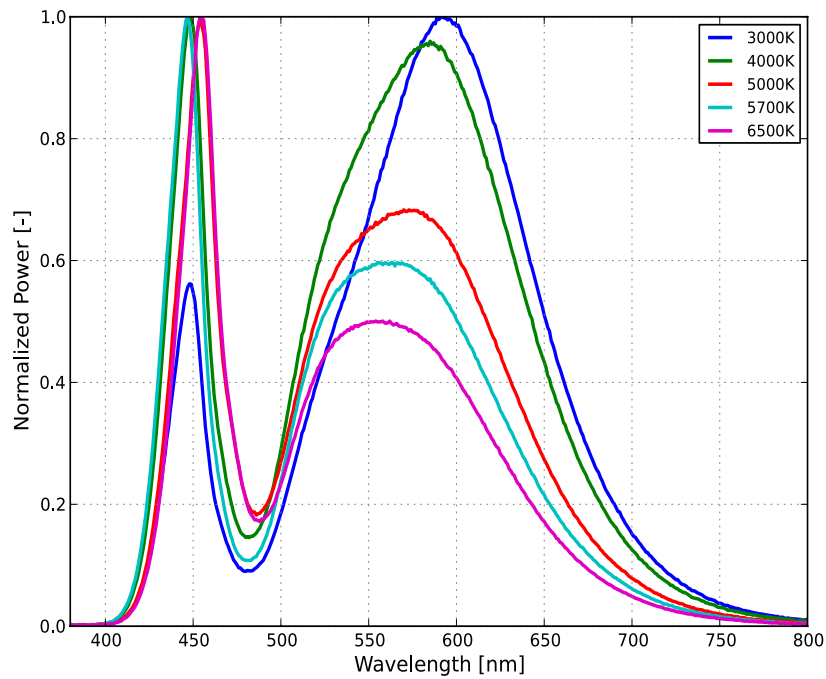

Figure 1a: Typical normalized power vs. wavelength for LXH7-FWxx at 700mA, $T_j=85^\circ\text{C}$.

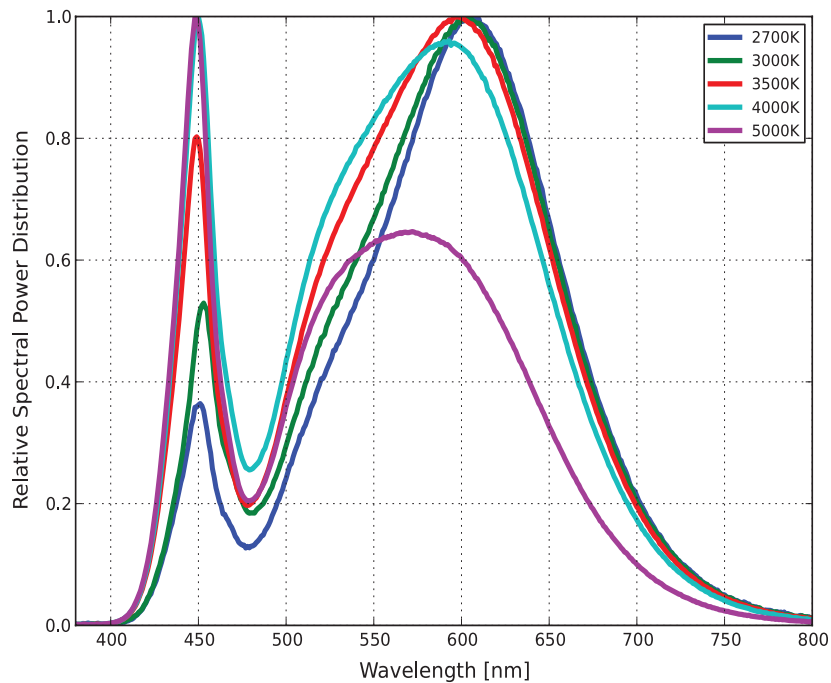

Figure 1b: Typical normalized power vs. wavelength for LXH8-FWxx at 700mA, $T_j=85^\circ\text{C}$.

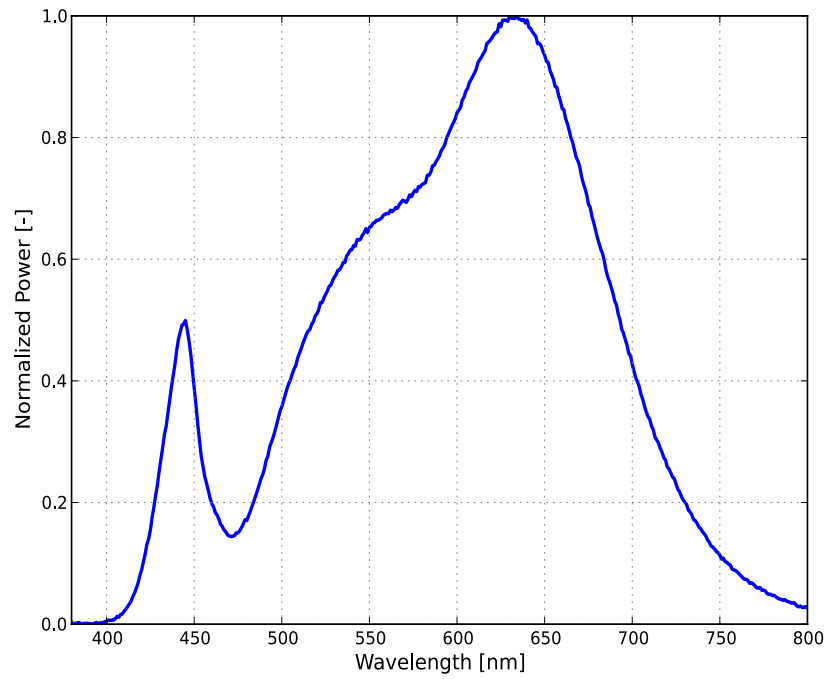

Figure 1c: Typical normalized power vs. wavelength for LXH7-FWxx at 700mA, $T_j=85^{\circ}\text{C}$.

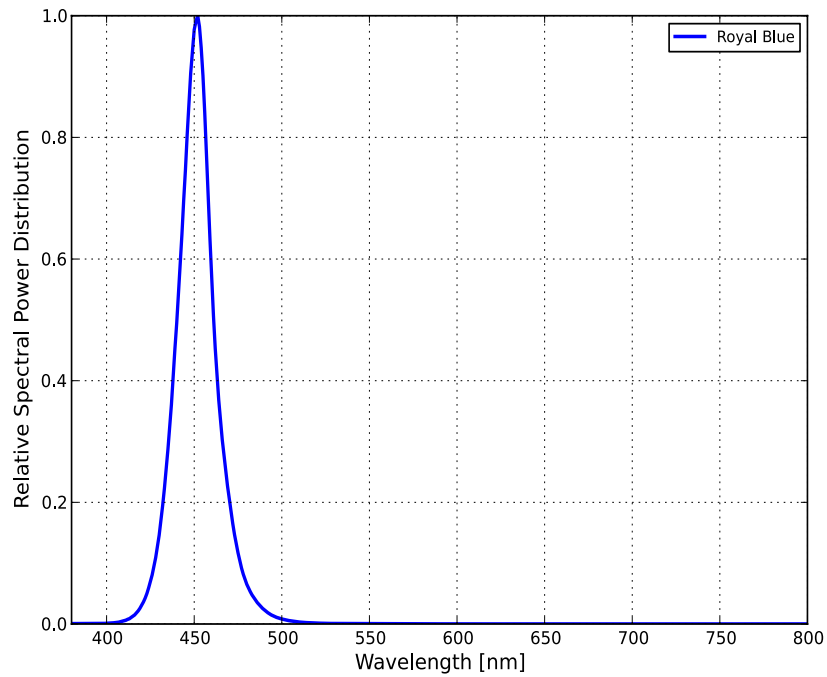

Figure 1d: Typical normalized power vs. wavelength for LXHx-FWRB at 700mA.

Light Output Characteristics

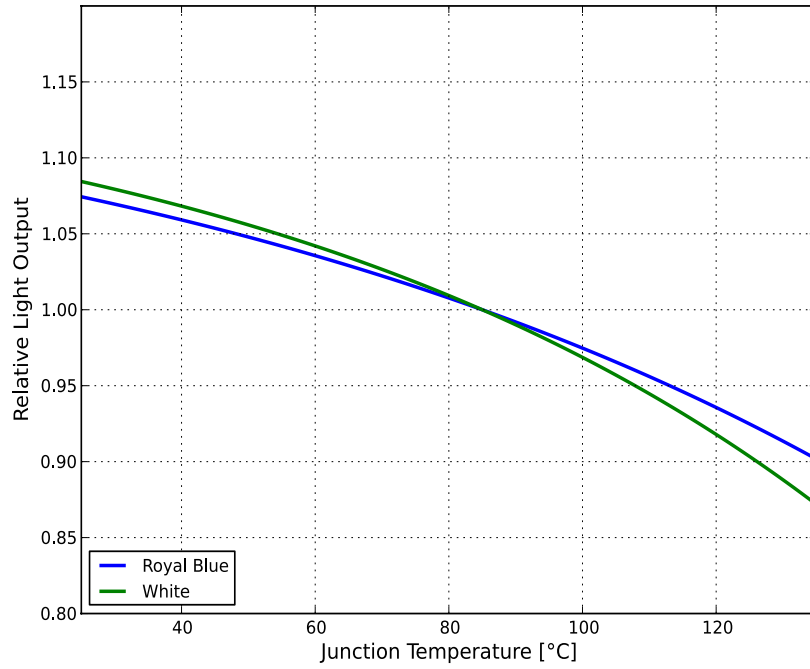

Figure 2a: Typical normalized light output vs. junction temperature for LXFx-FWxx at 700mA.

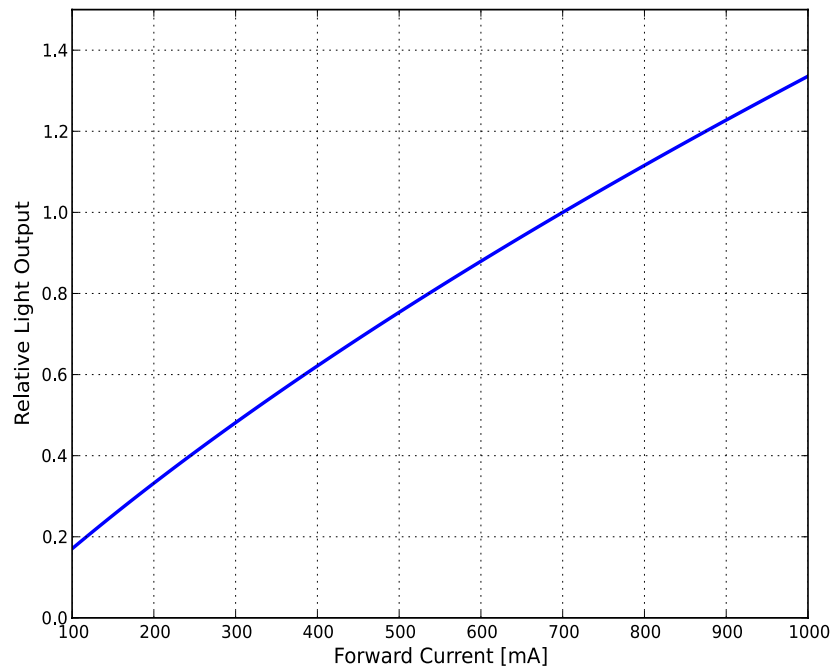

Figure 2b: Typical normalized light output vs. forward current for LXFx-FWxx at $T_j=85^\circ\text{C}$.

Forward Current Characteristics

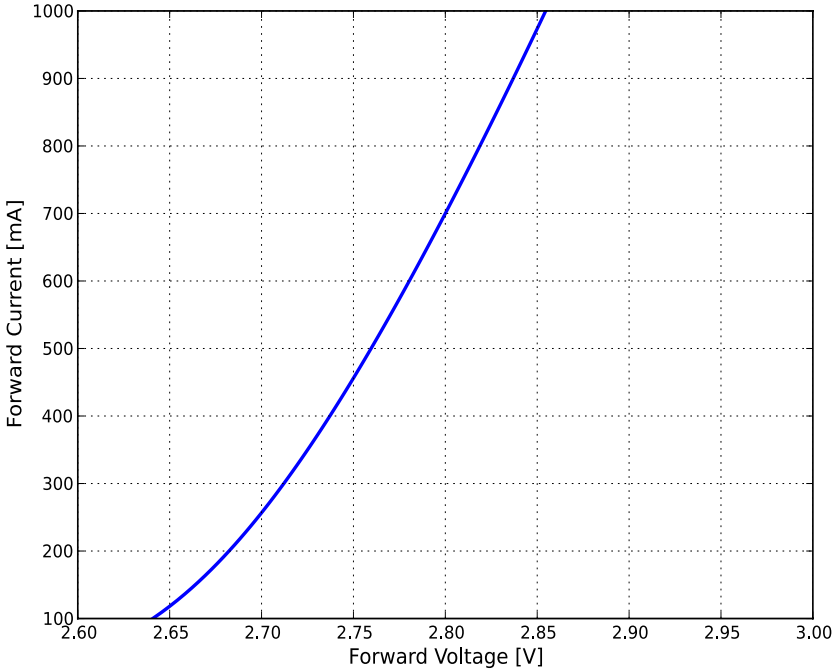

Figure 3a: Typical forward current vs. forward voltage for LXHx-FWxx at $T_j=85^\circ\text{C}$.

Radiation Pattern Characteristics

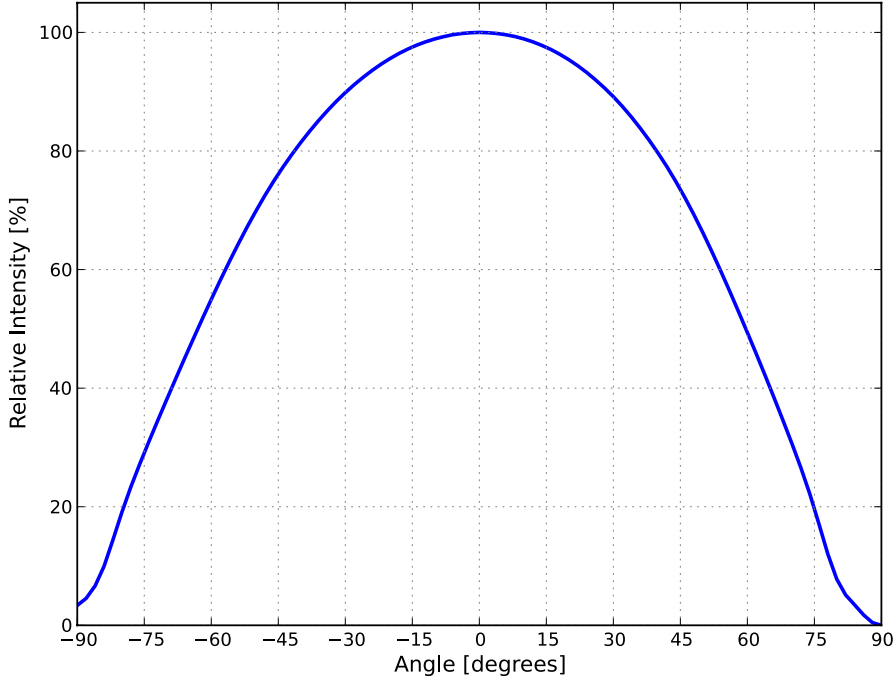

Figure 4a: Typical radiation pattern for LXHx-FWxx at 700mA, $T_j=85^{\circ}\text{C}$.

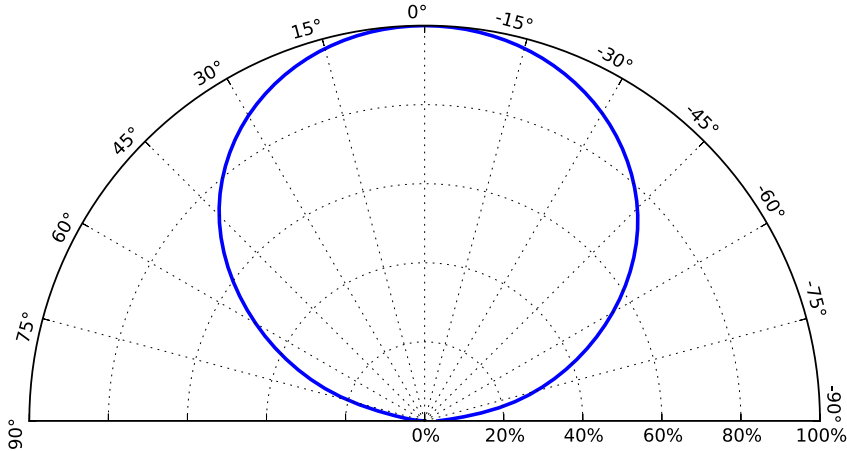

Figure 4b: Typical polar radiation pattern for LXHx-FWxx at 700mA, $T_j=85^{\circ}\text{C}$.

Product Bin and Labeling Definitions

Decoding Product Bin Labeling

In the manufacturing of semiconductor products, there are variations in performance around the average values given in the technical datasheet. For this reason, Lumileds bins LED components for luminous flux or radiometric power, color point, peak or dominant wavelength and forward voltage.

LUXEON T LEDs are labeled using a 4-digit alphanumeric CAT code following the format below:

A B C D

- A** – designates luminous flux or radiometric power bin (example: M=210 to 220 lumens, R=250 to 260 lumens)
- B** – designates correlated color temperature bin (0=Royal Blue, 1=6500K, 2=5700K, 3=5000K, 5=4000K, 6=3500K, 7=3000K, 8=2700K)
- C** – designates SDCM or peak wavelength bin (3=3-step MacAdam ellipse, 4=445 to 450nm, 5=450 to 455nm or 5-step MacAdam ellipse, 6=455 to 460nm, A, B, C or D=5-step specified bin)
- D** – designates forward voltage bin (example: P=2.50 to 2.75V, S=3.00 to 3.25V)

Therefore, a LUXEON T with a lumen range of 210 to 220, color bin of 7 designating 3000K parts, 3-step MacAdam ellipse 80CRI and a forward voltage range of 2.50 to 2.75V has the following CAT code:

M 7 3 P

Luminous Flux Bins

Table 5 lists the standard photometric luminous flux bins for LUXEON T emitters. Although several bins are outlined, product availability in a particular bin varies by production run and by product performance. Not all bins are available in all CCTs.

Table 5. Luminous flux bin definitions for LUXEON T.

BIN	LUMINOUS FLUX (lm)	
	MINIMUM	MAXIMUM
C	120	130
D	130	140
E	140	150
F	150	160
G	160	170
H	170	180
J	180	190
K	190	200
L	200	210
M	210	220
N	220	230
P	230	240
Q	240	250
R	250	260
S	260	270
T	270	280
U	280	290
V	290	300

Notes for Table 5:

1. Lumileds maintains a tolerance of $\pm 6.5\%$ on luminous flux measurements.

Radiometric Power Bins

Table 6. Radiometric power bins for LUXEON T Royal Blue.

BIN CODE	RADIOMETRIC POWER (mW)	
	MINIMUM	MAXIMUM
A	950	1000
B	1000	1050
C	1050	1100
D	1100	1150
E	1150	1200
F	1200	1250

Notes for Table 6:

1. Lumileds maintains a tolerance of $\pm 6.5\%$ on radiometric tolerance measurements.

Color Bin Definition

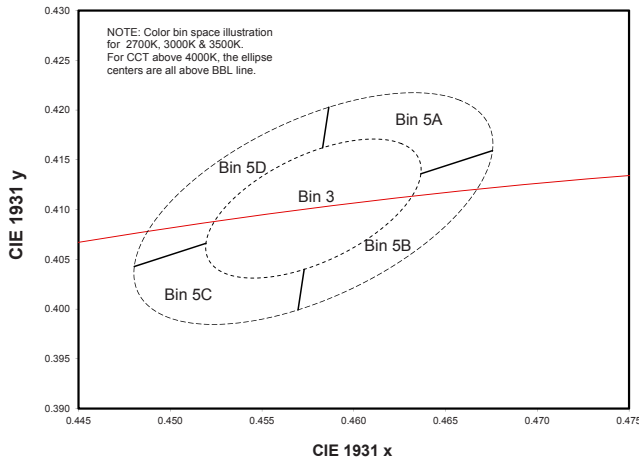

Figure 5: Color space definition for LUXEON T.

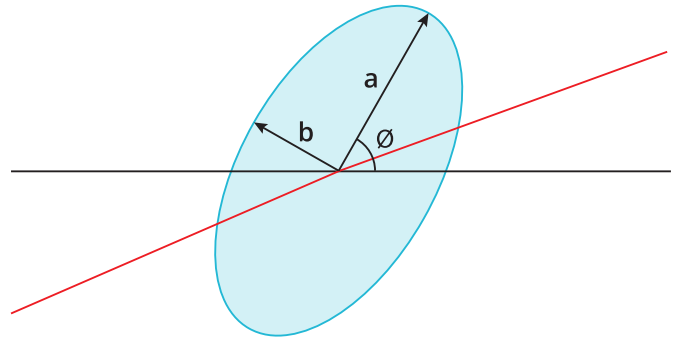

Figure 6: 3- and 5-step MacAdam ellipse illustration for Table 7.

Table 7. 3- and 5-step MacAdam ellipse color bin definitions for LUXEON T.

NOMINAL CCT	COLOR SPACE	CENTER POINT (cx, cy)	MAJOR AXIS, a	MINOR AXIS, b	ELLIPSE ROTATION ANGLE, θ
2700K	Single 3-step MacAdam ellipse	(0.4578, 0.4101)	0.00810	0.00420	53.70°
3000K	Single 3-step MacAdam ellipse	(0.4338, 0.4030)	0.00834	0.00408	53.20°
3500K	Single 3-step MacAdam ellipse	(0.4073, 0.3917)	0.00927	0.00414	54.00°
4000K	Single 3-step MacAdam ellipse	(0.3818, 0.3797)	0.00939	0.00402	53.70°
5000K	Single 3-step MacAdam ellipse	(0.3447, 0.3553)	0.00822	0.00354	59.60°
2700K	Single 5-step MacAdam ellipse	(0.4578, 0.4101)	0.01350	0.00700	53.70°
3000K	Single 5-step MacAdam ellipse	(0.4338, 0.4030)	0.01390	0.00680	53.20°
3500K	Single 5-step MacAdam ellipse	(0.4073, 0.3917)	0.01545	0.00690	54.00°
4000K	Single 5-step MacAdam ellipse	(0.3818, 0.3797)	0.01565	0.00670	53.70°
5000K	Single 5-step MacAdam ellipse	(0.3447, 0.3553)	0.01370	0.00590	59.60°
5700K	Single 5-step MacAdam ellipse	(0.3287, 0.3417)	0.01243	0.00533	59.09°
6500K	Single 5-step MacAdam ellipse	(0.3123, 0.3282)	0.01115	0.00475	58.57°

Notes for Table 7:

- Lumileds maintains a tolerance of ± 0.005 on x and y color coordinates in the CIE 1932 color space.

Table 8. Correlated color temperature bin definitions for LUXEON T.

BIN	CCT
0	Royal Blue
1	6500K
2	5700K
3	5000K
5	4000K
6	3500K
7	3000K
8	2700K

Table 9. MacAdam ellipse color bin definitions for LXHx-FWxx (white).

BIN	SDCM or WAVELENGTH (nm)
3	3-step MacAdam ellipse
5	5-step MacAdam ellipse
A	5-step MacAdam ellipse
B	5-step MacAdam ellipse
C	5-step MacAdam ellipse
D	5-step MacAdam ellipse

Peak Wavelength Bins

Table 10. Peak wavelength bins for LXHx-FWRB at 700mA, $T_j=85^\circ\text{C}$.

BIN	PEAK WAVELENGTH (nm) ⁽¹⁾	
	MINIMUM	MAXIMUM
4	445	450
5	450	455
6	455	460

Notes for Table 10:

1. Lumileds maintains a tolerance of $\pm 2\text{nm}$ on peak wavelength measurements.

Forward Voltage Bins

Table 11. Forward voltage bin definitions for LUXEON T.

BIN	FORWARD VOLTAGE (V) ⁽¹⁾	
	MINIMUM	MAXIMUM
P	2.50	2.75
R	2.75	3.00
S	3.00	3.25
X	2.65	2.85
Y	2.85	3.00

Notes for Table 11:

1. Lumileds maintains a tolerance of $\pm 0.06\text{V}$ on forward voltage measurements.

Mechanical Dimensions

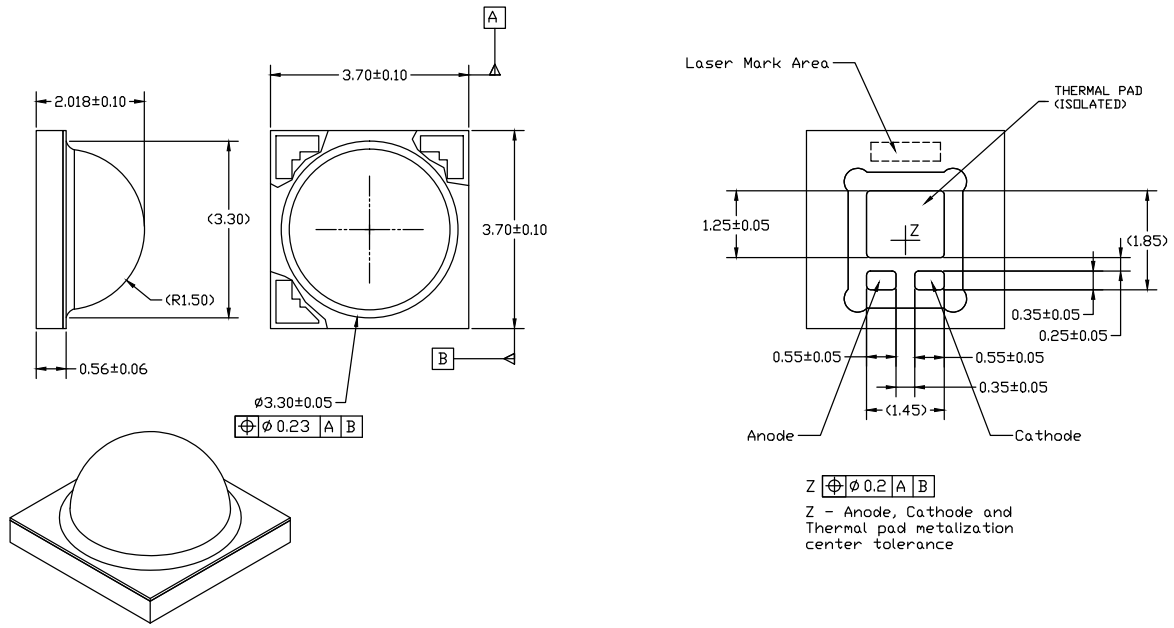

Figure 7: Mechanical dimensions for LUXEON T.

Notes for Figure 7:

1. Drawings are not to scale.
2. All dimensions are in millimeters.
3. Do not handle the device by the dome. Excessive force on the dome may damage the dome itself or the interior of the device.

Reflow Soldering Guidelines

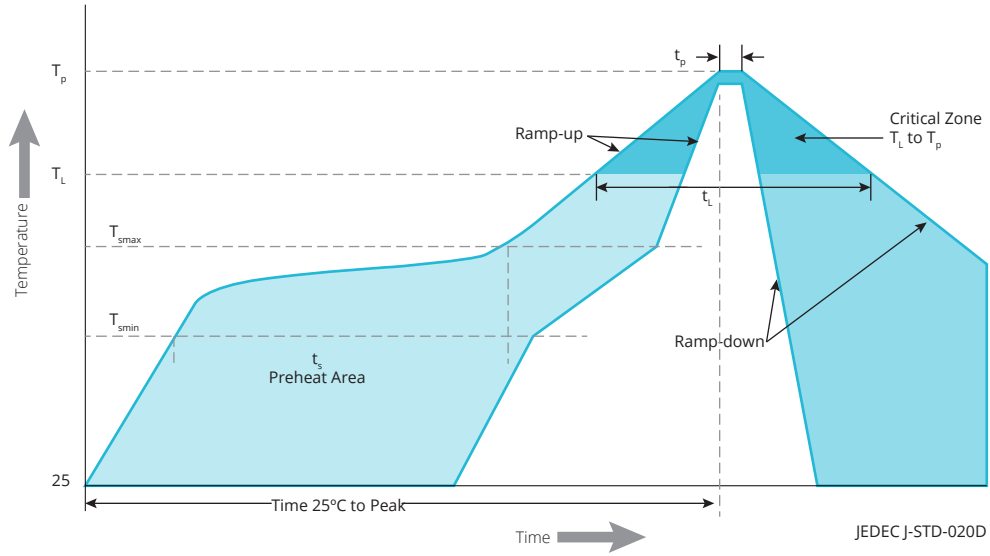

Figure 8: Visualization of the acceptable reflow temperature profile as specified in Table 12.

Table 12. Reflow profile characteristics for LUXEON T.

PROFILE FEATURE	LEAD-FREE ASSEMBLY
Preheat Minimum Temperature (T_{smin})	150°C
Preheat Maximum Temperature (T_{smax})	200°C
Preheat Time (t_{smin} to t_{smax})	60 to 120 seconds
Ramp-Up Rate (T_{smax} to T_p)	3°C / second maximum
Liquidus Temperature (T_L)	217°C
Time Maintained Above Temperature T_L (t_t)	60 to 150 seconds
Peak / Classification Temperature (T_p)	260°C
Time Within 5°C of Actual Temperature (t_p)	20 to 40 seconds
Ramp-Down Rate	6°C / second maximum
Time 25°C to Peak Temperature	8 minutes maximum

JEDEC Moisture Sensitivity

Table 13. Moisture sensitivity levels for LUXEON T.

LEVEL	FLOOR LIFE		SOAK REQUIREMENTS STANDARD	
	TIME	CONDITIONS	TIME	CONDITIONS
1	Unlimited	≤30°C / 85% RH	168 Hours +5 / -0	85°C / 85% RH

Solder Pad Design

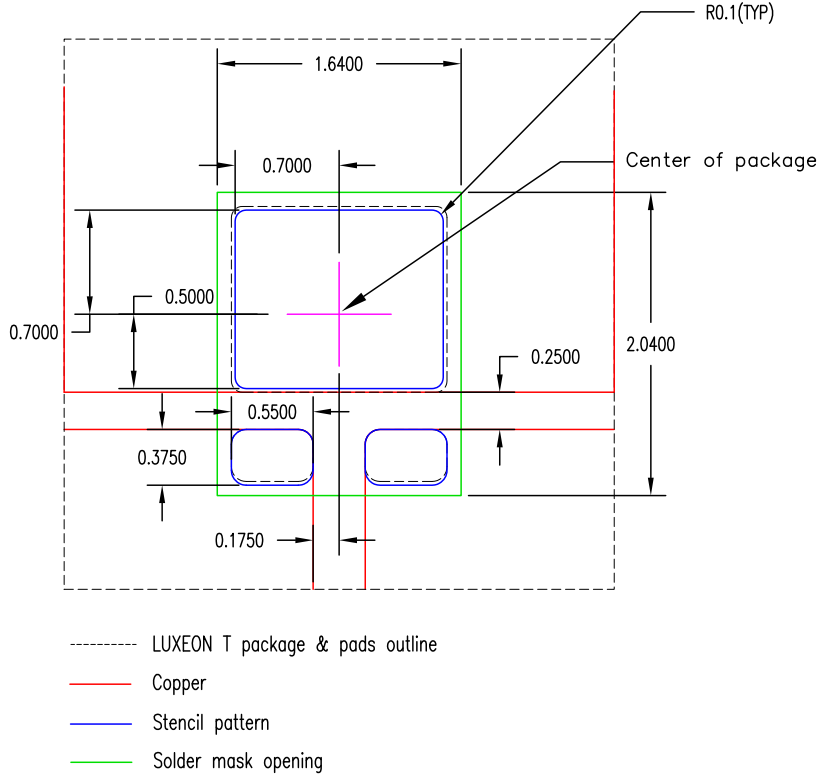

Figure 9: Recommended PCB solder pad layout for LUXEON T.

- Notes for Figure 9:
1. Drawings are not to scale.
 2. All dimensions are in millimeters.

Packaging Information

Pocket Tape Dimensions

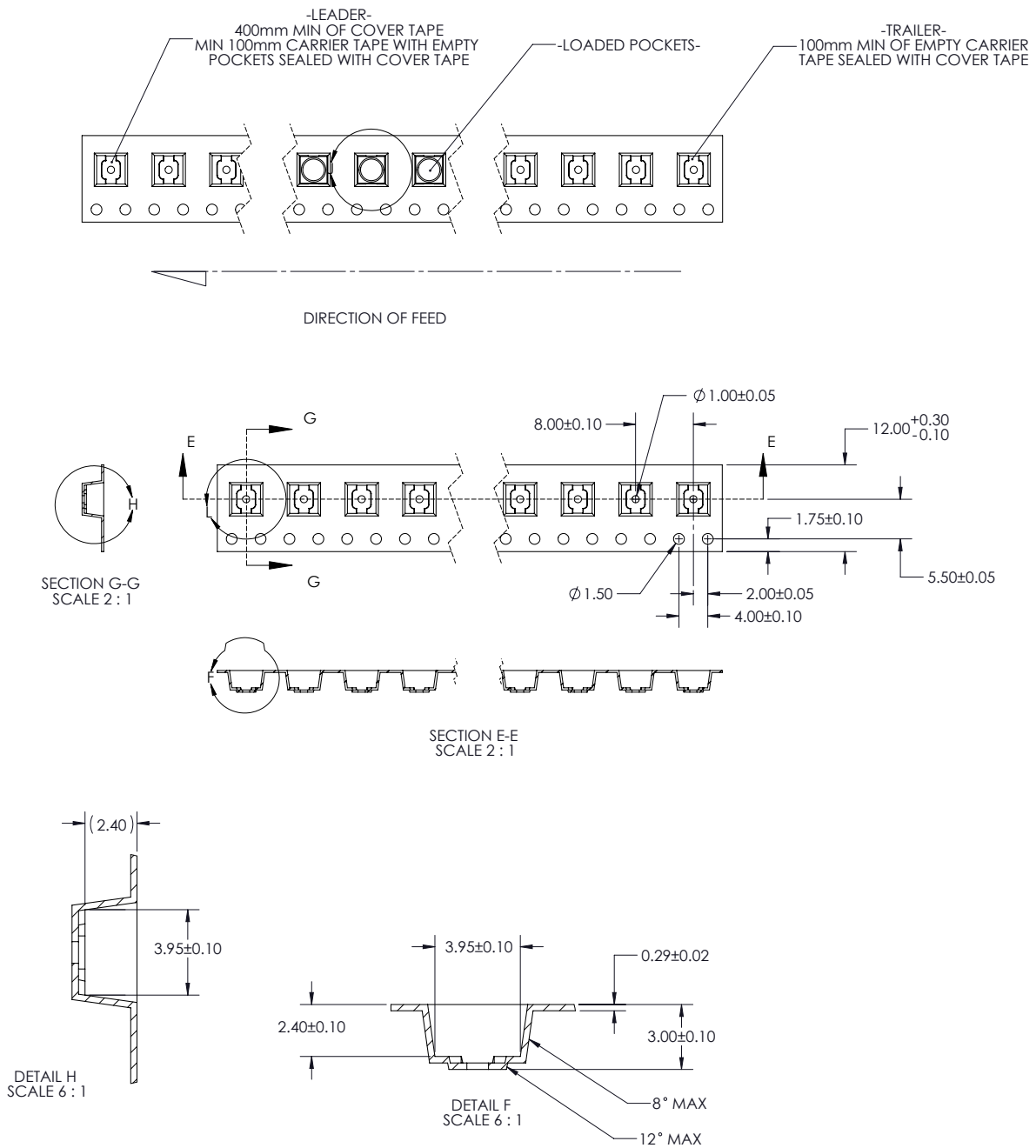

Figure 10: Packaging dimensions for LUXEON T.

Notes for Figure 10:

1. Drawings are not to scale.
2. All dimensions are in millimeters.

Reel Dimensions

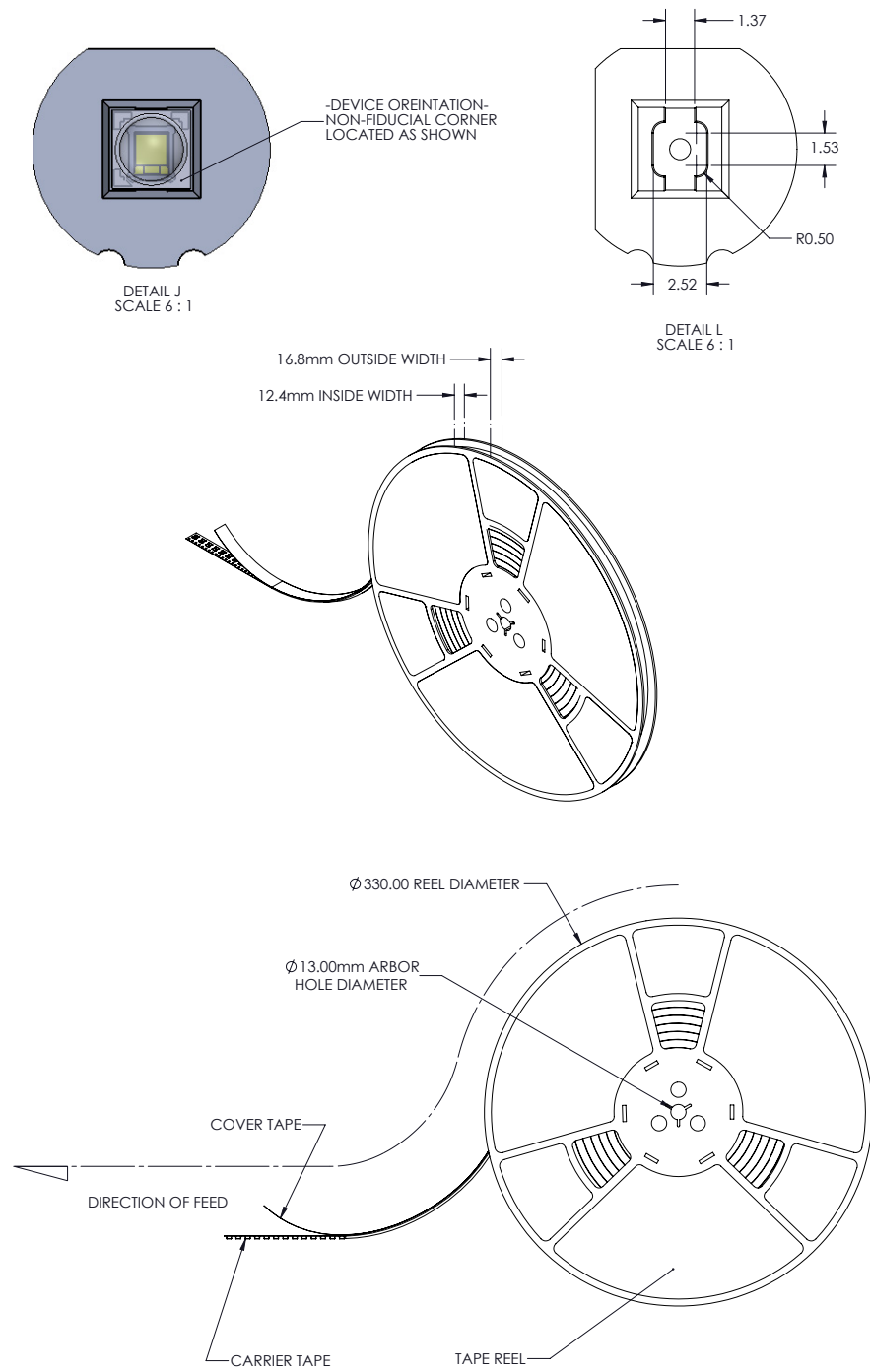

Figure 11: Reel dimensions for LUXEON T.

Notes for Figure 11:

1. Drawings are not to scale.
2. All dimensions are in millimeters.

About Lumileds

Lumileds is the global leader in light engine technology. The company develops, manufactures and distributes groundbreaking LEDs and automotive lighting products that shatter the status quo and help customers gain and maintain a competitive edge.

With a rich history of industry “firsts,” Lumileds is uniquely positioned to deliver lighting advancements well into the future by maintaining an unwavering focus on quality, innovation and reliability.

To learn more about our portfolio of light engines, visit lumileds.com.



©2017 Lumileds Holding B.V. All rights reserved.
LUXEON is a registered trademark of the Lumileds Holding B.V.
in the United States and other countries.

lumileds.com

Neither Lumileds Holding B.V. nor its affiliates shall be liable for any kind of loss of data or any other damages, direct, indirect or consequential, resulting from the use of the provided information and data. Although Lumileds Holding B.V. and/or its affiliates have attempted to provide the most accurate information and data, the materials and services information and data are provided “as is,” and neither Lumileds Holding B.V. nor its affiliates warrants or guarantees the contents and correctness of the provided information and data. Lumileds Holding B.V. and its affiliates reserve the right to make changes without notice. You as user agree to this disclaimer and user agreement with the download or use of the provided materials, information and data.